

CFT/300

Cimatrice singola bilama
idraulica con topping

Hydraulic double blade single trimmer
with topping



cod. 103211L - versione allestita con distributore idraulico - *version equipped with hydraulic distributor*
cod. 103211J - versione allestita con distributore elettroidraulico - *version equipped with electro-hydraulic distributor*

Cimatrice a struttura centrale fissa completa di barra verticale L 200 cm. e topping superiore L. 100 cm. bilama e ammortizzate. Dispone di un distributore idraulico a 5 leve (4 + on/off motori): spostamento laterale; alzata verticale, inclinazione barra di taglio verticale, inclinazione a 90° topping superiore e on/off motori.

Possibilità di regolare la velocità delle lame direttamente dal distributore. Cavalletto di stazionamento di serie, Richiede 1 coppia di prese idrauliche del trattore con 25 lt/min e 180 bar/max. di pressione.

Trimmer with fixed column complete with a cushioned doubled bladed vertical L 200 cm. bar and L. 100 cm. upper topping bar. Equipped with a hydraulic distributor with 5 levers (4 + on/off motors): side extension; vertical lift, vertical cutting tilt bar, upper topping 90° tilt bar and on/off motors. Option to regulate the speed of the blades directly from the distributor. Standard parking tripod, requiring 1 pair of hydraulic tractor connectors with 25 lt/min and 180 bar/max. of pressure.

Alzata verticale idraulica topping
Topping hydraulic vertical lift



OPTIONAL

Sistema antiurto barra falciante con molla a gas
Mowing bar shockproof system with gas spring



DOTAZIONI DI SERIE - STANDARD EQUIPMENT

Spostamento laterale ed inclinazione barra verticale idraulico
Side extension and hydraulic vertical tilt bar

Pistone idraulico alzata verticale idraulico
Hydraulic vertical lift hydraulic piston

Inclinazione meccanica barra verticale
Vertical bar mechanical regulation

Molla antiurto rientro topping e pistone idraulico per rotazione 90°
Topping return emergency spring and hydraulic piston for 90° rotation

Coppia di tubi ad innesti rapidi al trattore
Oil supply and return quick couplings

Sistema di taglio bilama
Double blade cutting system



Distributore idraulico 4+1 montato sulla versione 103211L
4+1 hydraulic distributor fitted on the 103211L version



Distributore elettroidraulico 4+1 montato sulla versione 103211J
4+1 electro-hydraulic distributor fitted on the 103211J version



DATI TECNICI
SPECIFICATIONS

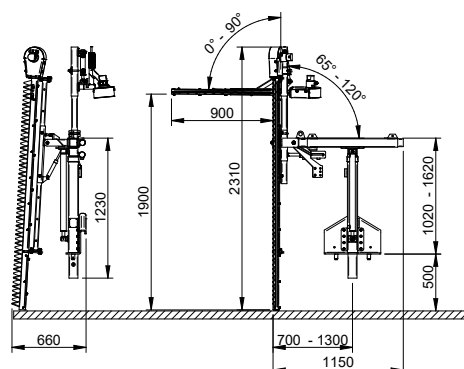

POSIZIONE DI LAVORO
WORKING POSITION

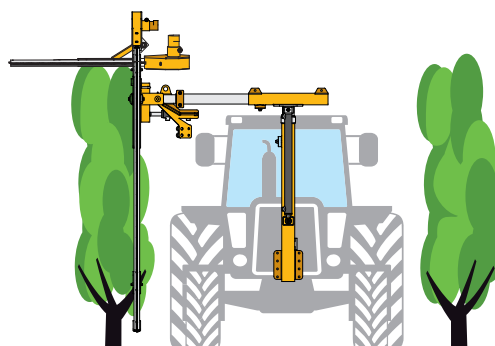











PESO
WEIGHT

180 Kg

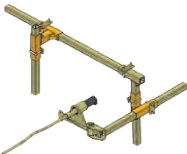
ACCESSORI per cimatrici bilama

ACCESSORIES for double blade trimmers

COD	IMG	DESCRIPTION	MOD.
cod.1A32200		Kit convogliatore alza tralci <i>Conveyor kit for lifting branches</i>	ECO/200 - CF/200 - CFT/300 CM/200 - CMT/300
cod.1A32220		Kit 2 convogliatori alza tralci <i>2 conveyors kit for lifting branches</i>	ECO/400 - CFU/500 - CMU/500 CFT2/600 - CMT2/600
cod.1A32050		Staffa fissa al trattore (fornire il modello di trattore) <i>Bracket fixed to the tractor (supply the tractor model)</i>	ECO/200 - ECO/400 - CF/200 - CFT/300 CFU/500 - CM/200 - CMT/300 - CMU/500 CFT2/600 - CMT2/600
cod.1A32070		Kit attacco a tre punti con aggancio rapido <i>3 point attachment kit with quick coupling</i>	ECO/200 - ECO/400 - CF/200 - CFT/300 CFU/500 - CM/200 - CMT/300 CMU/500 - CMT2/600
cod.1A48000		Serbatoio idraulico posteriore indipendente con radiatore, pompa gr. 2 e 60 lt di olio <i>Independent rear hydraulic tank with radiator, gr. 2 pump and 60 lt. oil.</i>	ECO/200 - ECO/400 - CF/200 - CFT/300 CFU/500 - CM/200 - CMT/300 - CMU/500 CFT2/600 - CMT2/600
cod.1A40000		Kit testata spollonatrice <i>Shoot remover head kit</i>	CF/200 - CFT/300 CM/200 - CMT/300
cod.1A44000		Kit stralciatore motorizzato <i>Kit barra GDC superiore con inclinazione idraulica</i>	CF/200 - CFT/300 - CFU/500 CM/200 - CMT/300 - CMU/500
cod.1A44110		Barra falciante da secco L.75 cm <i>Dry mowing bar L.75 cm</i>	CF/200 - CFT/300 - CFU/500 CM/200 - CMT/300 - CMU/500
cod.1A32320		Alzata idraulica per topping <i>Hydraulic lift for topping</i>	CFT/300 - CMT/300
cod.1A32330		Alzata elettroidraulica per topping <i>Electro-hydraulic lift for topping</i>	CFT/300 - CMT/300