



(<https://www.celli.it/en/>)

# VIRGO

## Side-shift mulcher

HP 40-70 KW 29-51

[More information / Download PDF](#)



Suitable for cleaning ditches, road shoulders, meadows and gardens

### Technical specifications and standard equipment

- maximum horsepower: 70 HP (51 KW)
- PTO: 1-Speed for 540 rpm: 2,454 rpm tip speed 43 m/s
- 3 belt transmission
- 3-point hitch cat. 2 with self-aligning hinge – fixed
- fixed double counter-blades
- gearbox with freewheel safety device
- side skids and rear roller (ø 133 mm) for cutting height adjustment
- side-shift and tilt (angle) adjustment with hydraulic rams
- rotor (pipe ø 108 mm) with smooth hammers (ø 336 mm)
- resting foot

- drive shaft without safety device



## Optional accessories







[.it/en/](https://www.celli.it/en/)

- Drive shaft with wide-angle yoke
- L-shaped blades
- Toothed hammers

## Ideal for:

- Working with small tractors
- Mulching grass and shoots
- Cultivating around trees in vineyards and orchards
- Cutting grass
- Cutting grass on slopes
- Carrying equipment on the roads without risks

**Symbol key (<https://www.celli.it/en/symbol-key/>)**

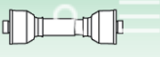
						
( <a href="https://www.celli.it/en/">https://www.celli.it/en/</a> )	cm	cm	HP / KW	Kg	Nr.	
<b>150</b>	166	150	40/29	530	12	Cardano S.6 L=1656 lato trattore 1"3/8 Z=6
<b>165</b>	181	165	45/33	555	14	
<b>180</b>	196	180	50/36	575	16	

VIRGO	A	B	C	C1	D
	cm	cm	cm	cm	cm
<b>150</b>	150	230	58	69	180/197
<b>165</b>	165	245	58	69	180/197
<b>180</b>	180	260	58	69	180/197

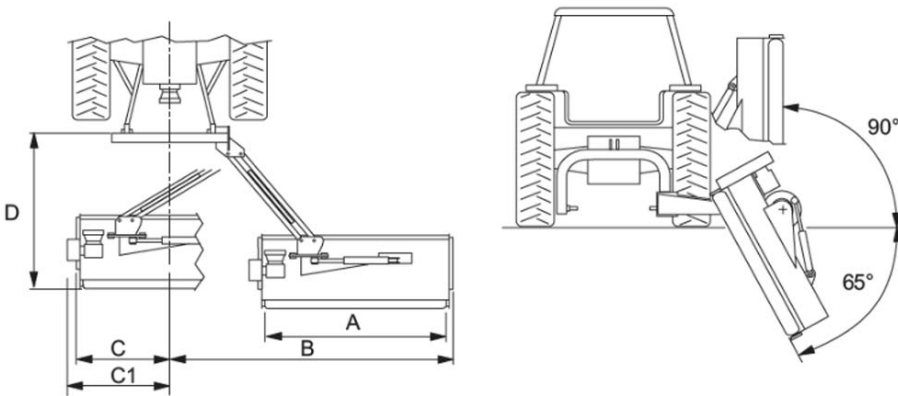

Previous

« SCORPIO/P

SUPER SCORPIO/P (<https://www.celli.it/en/products/mulchers/scorpio-psuper-scorpio-p/>)

Next

VIRGO SE » (<https://www.celli.it/en/products/mulchers/virgo-se/>)

## Request for information

Fill out the form to ask for information on the product pages