



(<https://www.celli.it/en/>)

PEGASUS

Side-shift mulcher

HP 55-110 KW 40-81

[More information / Download PDF](#)



Suitable for cleaning ditches, road shoulders, meadows, gardens, shrubs and wood branches (Ø 6-7 cm)

Technical specifications and standard equipment

- maximum horsepower: 110 HP (81 KW)
- PTO: 1-Speed for 540 rpm: 2,278 rpm tip speed 52.5 m/s
- 4 belt transmission
- 3-point hitch cat. 2 with self aligning hinge and mechanical shock absorber
- front and upper counter-blades
- rear roller Ø 194 mm
- side-shift and tilt (angle) adjustment using hydraulic rams
- gearbox with freewheel safety device
- side skids
- rotor (Ø pipe 168 mm) with flat hammers (Ø 430 mm – Ø 440 mm)



- resting feet

• Removable shielded box frame
(<https://www.celli.it/en/>)





Optional accessories

- 3 tines (2 Y-shaped blades + 1 straight blade)
- Drive shaft with wide-angle yoke
- Wear-proof plates for side-skids (pair)
- Shock-absorber with pressure relief valve fitted onto side-shift ram

Ideal for:

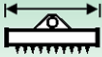
- Working with medium sized tractors
- Mulching grass and shoots
- Mulching shoots and cutting wood
- Mulching stalks and plant residue
- Cultivating around trees in vineyards and orchards
- Cutting grass
- Cutting grass on slopes
- Carrying equipment on the roads without risks

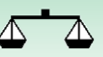
Symbol key (<https://www.celli.it/en/symbol-key/>)

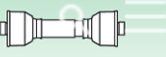
						
(https://www.celli.it/en/)	cm	cm	HP / KW	Kg	Nr.	
175	195	175	55/40	780	16	Cardano S.6 L=1656 lato trattore 1"3/8 Z=6
200	220	200	65/48	810	18	
225	246	225	75/55	860	20	
250	270	250	85/63	915	22	

PEGASUS	A	B	C	C1	D
	cm	cm	cm	cm	cm
175	175	250	63	78	197 - 213
200	200	266	72	87	197 - 213
225	225	291	72	87	197 - 213
250	250	316	72	87	197 - 213

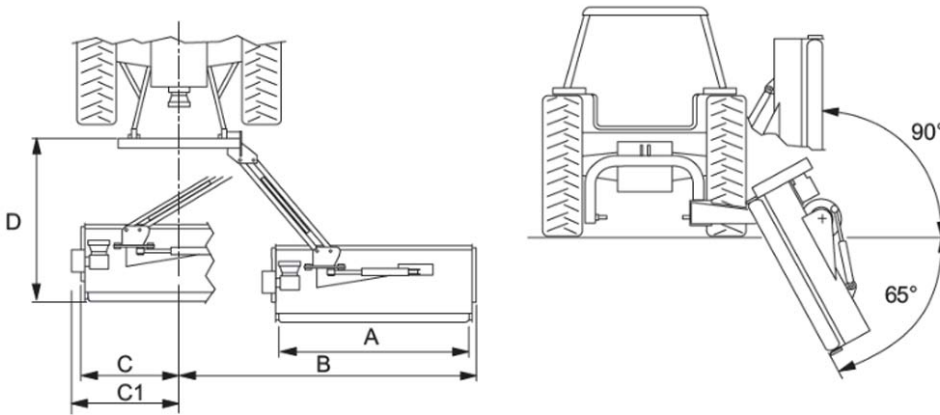

Previous

« VIRGO SE (<https://www.celli.it/en/products/mulchers/virgo-se/>)

Next

PEGASUS SE » (<https://www.celli.it/en/products/mulchers/pegasus-se/>)

Request for information